



## Phased array antenna using MEMS phase shifter

Ali Azarbar<sup>1</sup>, Masoud Dahmardeh<sup>2\*</sup>, Mohammad Mahdi Taskhiri<sup>3</sup>

<sup>1</sup>Electrical Engineering Department, Islamic Azad University, Parand Branch, Tehran, Iran

<sup>2</sup>School of Automotive Engineering, Iran University of Science and Technology, Tehran, Iran

<sup>3</sup>Electrical Engineering Department, Qom University of Technology, Qom, Iran

### ARTICLE INFO

#### Article history:

Received : 27 Jan 2018

Accepted: 1 Jun 2018

Published: 1 Jun 2018

#### Keywords:

Automotive radar;

Phase array antenna;

MEMS phase shifter;

MEMS bridge;

CPW to microstrip transition;

### ABSTRACT

This article presents a phased array antenna employing MEMS phase shifter. The proposed phased array antenna consists of eight square patch antennas operating at 10.4 GHz with a bandwidth of 400 MHz. Feed line for each patch passes through a MEMS phase shifter realized by a series of bridges above the transmission line. The distance between the bridge and the transmission line underneath it is adjusted using a control signal applied to them, which in turn, introduces a loading effect on the feed signal. This changes the effective length of the feed line and provides phase shifts with 15-degree resolution. Low loss conversion units are employed in order to couple the phase shifter and microstrip lines. The integrated numerical analysis approach applied to phased array antenna employing MEMS phase shifter and the scattering parameters and radiation patterns at different steering angles demonstrate the effectiveness of employing MEMS phase shifters in designing phased array antennas. The proposed design methodology might be applied to other frequency bands, such as millimeter-wave for automotive applications. Employment of MEMS phase shifters instead of solid-state ones provides high linearity, high power handling, and wide frequency range of operation.

## 1. Introduction

Automotive radars are getting more attention due to their application in improving comfort features and reducing road accidents [1]. Figure 1 shows a schematic view of the adaptive cruise control components [2]. The radar provides information about the traffic, speed of adjacent vehicles, obstacles, and pedestrians. Their employment in various automotive applications includes but not

limited to parking assistance, adaptive cruise control, blind-spot detection and etc. On the other hand, intelligent vehicles, vehicle to vehicle communication, vehicle to infrastructure communications require radars with improved performance. Phased array antennas are important components, due to the ability of electronic beam steering and absence of moving components. This is realized by electronic phase control of the

\*Corresponding Author

Email Address: [mdahmardeh@iust.ac.ir](mailto:mdahmardeh@iust.ac.ir)

feed signal applied to the radiating elements. Therefore, beam shape can be controlled to any desired pattern pointing to any arbitrary direction without physical movement of the antenna components. This provides fast and accurate tracking of moving objects. Considering the importance of phase control, many recent studies are devoted to develop low-loss, inexpensive, and light phase shifters to be employed with phased array antennas.

Phase shifter is a two-port component that provides a certain phase shift between the input and output signals, using a control signal [3]. As phased array antennas are becoming more complex, designing phase shifters with low insertion loss, low power consumption, continuous adjustment, and low production cost is inevitable. Phase shifters are categorized to digital and analog. The digital one provides certain and pre-defined values of phase difference. On the other hand, analog phase shifters are able to provide continuous phase differences. Various phase shifter designs are reported in the literature. For instance, the electronic phase shifter proposed by Reggia and Spencer in 1957 was a major step, since mechanical phase shifters were unable to provide phase shifts with zero delay [4]. Ferrite phase shifters, an important type of phase shifters were introduced in mid 1960s, and are categorized under semiconductor phase shifters using PIN diodes as electronic control switches [5]. Since then, significant improvements are obtained in the field of electronic phase shifters. As semiconductors advances, GaAs FET phase shifters are developed, which has the advantage of integrating with electronic circuits [6]. Semiconductor phase shifters using PIN and FET diodes are cheaper and smaller compared with the ferrite ones, however, the high level of the associated insertion loss makes them less favorable [3]. Nowadays, research groups are studying phase shifters realized by micro-electro-mechanical systems (MEMS) to answer these challenges [7]. A phase shifter could be realized using MEMS switches either by adding capacitive loading to the feed line or switching between lines with different electrical lengths. RF MEMS switches behavior is similar to the conventional PIN and FET ones; however, the working principle is different. MEMS switches enjoy the benefits of both solid state technology as

well as electromechanical system technology. Electrostatic actuation is among the popular actuation forces employed in MEMS switches, due to the low level of power requirements [8]. Two popular MEMS switch mechanisms are the cantilever and air-bridge type [9]. Another type of MEMS phase shifter is the line loaded with shunt capacitance, in which as the feed line impedance changes, the phase difference is introduced. Rebeiz et al. proposed a MEMS phase shifter design based on the capacitive bridge [7]. Low insertion loss and large bandwidth are the advantage of using capacitive bridge.

Designing of MEMS phase shifters for the phased array antenna applications is reported in the literature. Sharma et al. reported a Ku band 5 bit MEMS phase shifter for active electronically steerable phased array applications. They used a hybrid approach of both loaded and switched line topologies [10]. Shah et al. proposed a submillimeter-Wave RF MEMS Phase Shifter. A linear phase shift of  $20^\circ$  in ten discrete steps is achieved [11]. Huang et al. reported a switched-line phase shifter based on MEMS switches operating at 1.7 to 2.7 GHz. The proposed design provides a maximum phase shift of  $75^\circ$  with a step of 5 degree [12]. A low-loss compact MEMS phase shifter for the frequency range of 24.5 to 26.5 GHz is reported. The design is based on aluminum coplanar waveguide (CPW) transmission line loaded with series capacitances and a phase shift of  $20^\circ$  is achieved [13]. Gurbuz and Rebeiz reported a  $360^\circ$  reflective type phase shifter at 2 GHz. The proposed method provides wide frequency range of operation, high linearity and power handling, as expected from MEMS devices [14].

Although, the MEMS phase shifter design for the phased array antenna applications is reported in the literature, however, what is less discussed is the integrated study of the phased array antenna with the presence of the MEMS phase shifter. This enables the designer to study the performance of the phase array antenna with various phase shifter designs. This article presents the design and analysis of a phased array antenna integrated with bridge MEMS phase shifter. Numerical analysis is carried out to investigate the antenna performance at different steering angles.

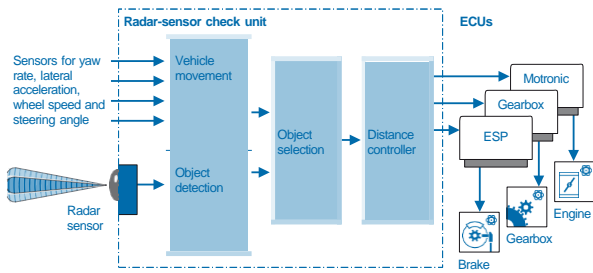


Figure 1: Schematic view of the adaptive cruise control (ACC) system [2].

It should be noted that the operating frequency for the automotive applications is in the millimeter-wave range, however, in this article, an X-band phased array antenna using square microstrip patches is presented and discussed. Nevertheless, the design consideration and concept are the same for other frequency bands. Phase shift is provided using MEMS phase shifter realized by 24 bridge MEMS switches arranged in series with the coplanar waveguide feed line. Since the radiation element feed lines and phase shifters are realized by different transmission lines, two microstrip to CPW transitions are used. The design of the MEMS phase shifter is presented and its effect of the performance of the phased array antenna is investigated. Since the input/output impedance matching significantly affects the performance of the array, therefore, the design should answer this challenge. On the other hand, the coupling between different stages should be considered during the design procedure. The MEMS phase shifter is designed and optimized to provide 360° phase shift, and is coupled to matching stages and radiating elements. The overall performance of the antenna is investigated. Numerical results of the radiation performance are studied for the steering angle of 15.7°. The obtained results suggest that using MEMS phase shifters is an effective way to produce phase shift in phased array antennas. Employment of MEMS phase shifters instead of solid-state ones, provides high linearity, high power handling, and wide frequency range of operation.

2. Feed Line and Antenna Design

Figure 2 shows the designed square patch antenna fed with microstrip line. A 1×8 linear array of patch antennas operating at 10.4 GHz is designed using transmission line method [15]. Rogers 5880 is used as the substrate due

to its high efficiency and low loss at high frequencies. The substrate thickness is 0.506 mm, and the loss and relative permittivity is  $\tan\delta=0.0002$  and  $\epsilon_r = 2.2$ , respectively. Sections I-VI shown in Figure 2 are for the feed network, and section VII is connected to the SMA connector with an impedance of 50 Ω. The optimized values of the feed line and antenna are listed in Table 1.

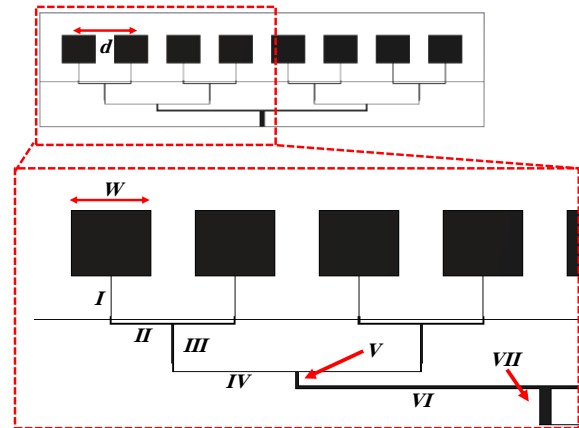


Figure 2: Schematic view of the phased array antenna and the feed lines.

3. Beam Steering and MEMS Phase Shifter

Phased arrays have the advantage of electronic steering the antenna beam. As shown in Figure 2, phased array antenna consists of radiating elements placed linearly and uniformly at specific distance from each other, so that the phase difference between elements is known. For example, for a linear array of  $n$  radiating elements with spacing  $d$  from each other, the feed signal amplitude for each element is the same. The phase difference  $\phi$  exists between adjacent radiating elements which is responsible for beam steering. The required phase shift between radiating elements due to different feed signal phase and path distance ( $\Psi$ ) is given by Equation (1) [16]:

$$\Psi = drcos(\delta) + \phi \tag{1}$$

**Table 1:** Optimized values of the feed line and antenna.

		Dimension (mm)		Dimension (mm)		Dimension (mm)	
<i>W</i>		10.94		<i>III</i>	<i>w</i>	0.26	
<i>d</i>		9.04			<i>l</i>	5.37	
<i>I</i>	<i>w</i>	0.07186		<i>IV</i>	<i>w</i>	0.053	
	<i>l</i>	15.53			<i>l</i>	18.06	
<i>II</i>	<i>w</i>	0.13		<i>V</i>	<i>w</i>	0.45	
	<i>l</i>	8.36			<i>l</i>	2.35	
					<i>VI</i>	<i>w</i>	0.45
						<i>l</i>	33.7
					<i>VII</i>	<i>w</i>	0.78
						<i>l</i>	40.6

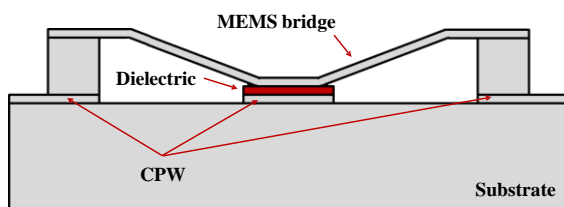
Where  $dr = 2\pi d/\lambda_0$  and  $\delta$  is the beam steer angle.

If the phase differences between the second, third, and  $n$ th radiating element with respect to the first one are  $\varphi, 2\varphi, (n-1)\varphi$ , then the beam is steered to angle  $\delta$ . As an example, in order to rotate the beam to  $\delta = 15^\circ$ , the required phase shift in this article ( $d = 0.522\lambda_0$ ) is calculated as described by Equation (2).

$$0 = (2\pi/\lambda_0)(0.522\lambda_0)\cos(15^\circ) + \varphi \quad (2)$$

which gives the required phase difference as  $\varphi = -60^\circ$ .

In order to realize the required phase difference using MEMS phase shifters, feed line loaded with shunt capacitances are used. In this technique, the electrical length of the feed signal line is modified by activating the shunt capacitances. Therefore, the required phase difference between radiating elements is obtained with negligible loss. The transmission line design shown in Figure 3 demonstrates this technique [17].



**Figure 3:** MEMS switch using bridges over the CPW.

A series of bridges, consist of a thin metal sheet suspended over the coplanar waveguide transmission line and anchored on two sides

of the line are used. As the control voltage is applied between the bridge and the line, the electrostatic force produces a deflection in the bridge towards the transmission line. A thin layer of dielectric deposited on the transmission line prevents short circuit between the bridge and the line. At radio frequencies (RF), as the metallic layer is pulled downward and touches the dielectric layer, RF short circuit is realized, which corresponds to the ON state of the phase shifter. As soon as the control voltage is shut down, the suspended layer returns to its rest state above the transmission line and at a specific distance, and does not have any effect on the RF signal, acts as an RF open circuit, and corresponds to the OFF state of the phase shifter.

While designing digital phase shifters, it is important to note the number of control bits. For instance, if a 5-bit phase shifter is needed, a number of 32 bridges should be used. Another design parameter is the maximum phase shift that the phase shifter should provide. Since the employed phase shifter for RADAR applications should be able to provide  $360^\circ$  phase shift, therefore, the required phase shift for phase shifter consisting of 24 bridges proposed in this article, should be equal to  $360/24 = 15^\circ$ . Several parameters are considered during the design procedure. The CPW line width, as well as the substrate material, determines the input impedance of the line. Other design parameters are the bridge height and line width. During the design of the proposed phase shifter in this article, dimensions are optimized to achieve the  $15^\circ$  phase shift. Therefore, the phase shift for the two cases where all bridges are down and when all bridges are up is  $360^\circ$ . The MEMS phase shifter impedance is matched to other sections using microstrip-CPW transition section.

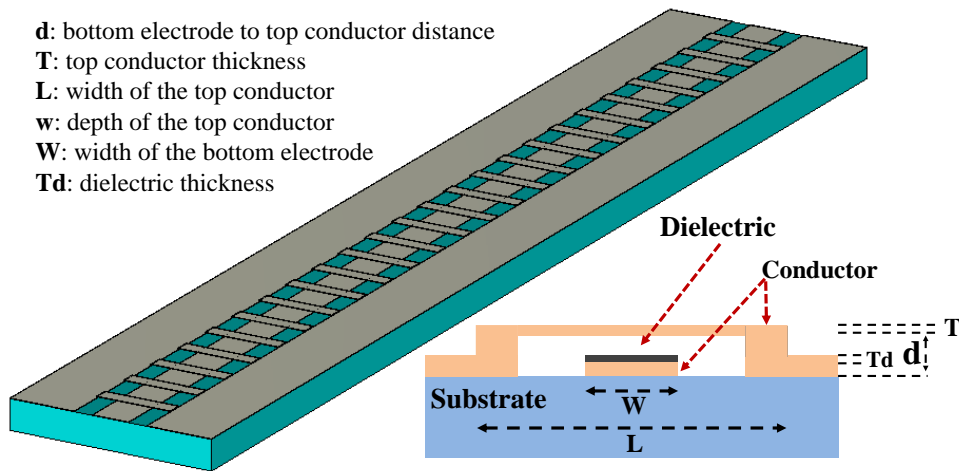


Figure 4: The proposed phase shifter employing 24 bridge MEMS switches.

Figure 4 shows the proposed phase shifter employing 24 bridge MEMS switches. Each bridge is actuated to up or down position via its own control signal. The up state shows the “OFF” state and the down state corresponds to the ‘ON’ state of the switch. The inset shows the cross section view of a bridge. A conductive plate is held above the transmission line. If the electrostatic force applied to the plate is higher than the spring force provided by the switch structure, the plate moves downward toward the bottom electrode and eventually makes contact with it. In order to prevent short circuit between them when the switch is ON, a dielectric layer is deposited on the bottom electrode. In order to analyze and design the switch, the downward electrostatic force and the spring force acting upward are considered. When the actuation voltage is applied between the transmission line and the suspended conductor, the electrostatic force acts upon them in the form of parallel plate capacitance force. Equation (3) states this force, in which  $V_h$  is the actuation voltage,  $x$  is the displacement, and  $d$  is the geometrical parameter.

$$F_{down} = \frac{\epsilon_0 \epsilon_a A_p V_b^2}{2(d-x)^2} \quad (3)$$

On the other hand, the mechanical force exerted on the suspended bridge follows the Hook law given by Equation (4).

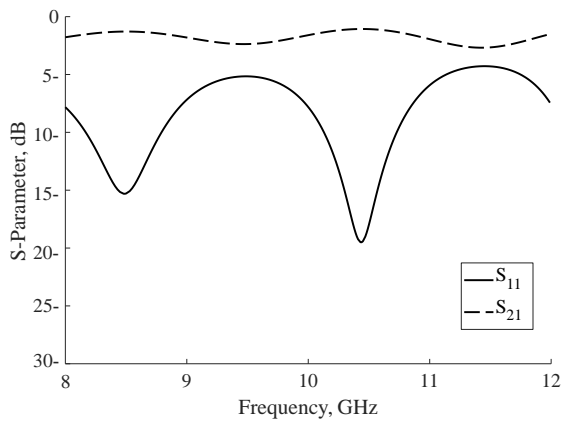
$$F_{up} = Kx \quad (4)$$

In which,  $K$  is the spring constant and the dimension is N/m. At equilibrium state, the above mentioned forces are equal to each other

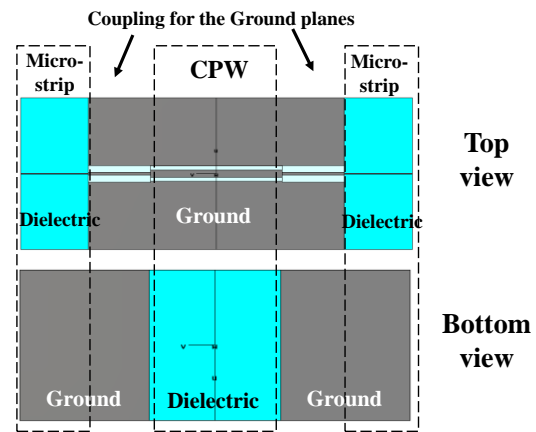
and the required actuation force to achieve an arbitrary displacement of  $x$  is obtained by equating equations (3) and (4). Differentiating with respect to  $x$ , the pull-in voltage which is required to turn ON the switch is found, which is described by Equation (5).

$$V_{pull-in} = \sqrt{\frac{8Kd^3}{27\epsilon_0 \epsilon_a A_p}} \quad (5)$$

The geometrical parameters of the phase shifter are optimized to achieve low insertion loss, return loss, matching with conversion units, and achieving the desired phase shift, using full-wave electromagnetic simulator CST Microwave Studio. Each bridge provides 15° phase shift for the passing RF signal. Therefore, when sufficient number of bridges are activated, phase shift of 360° is achieved, which is required for any required beam steering angle and array beam direction. As shown in Figure 5, the proposed phase shifter has low values of -20 dB and -1 dB for the return loss and insertion loss at the operating frequency of 10.4 GHz, respectively, which is better compared to the reported values, for instance, the hybrid design proposed by Sharma et al. with the values of -15 dB and -3.3 dB [10].



**Figure 5:** S-parameters of the proposed phase shifter (bridges are at up state).



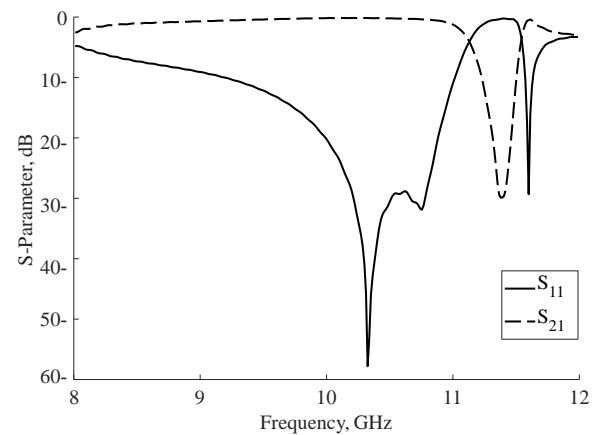
**Figure 6:** Microstrip to CPW conversion unit.

#### 4. Microstrip to CPW transition

As discussed and since the antenna feed is microstrip line and the phase shifter is designed on CPW line, therefore, conversion units are required to match these types of lines. The employed conversion units are the microstrip to CPW transition unit for the input feed signal to the phase shifters and CPW to microstrip transition unit for the phase shifter feed signal to the antenna. Figure 6 demonstrates a schematic view of the microstrip to CPW transition unit, which is designed according to the conventional methods [18]. Microstrip lines are located at the two ends of the transition unit and the phase shifter unit is located at the center. A coupling unit for the ground plane of the microstrip section at the bottom and the one for CPW section on top is designed which is located at the two ends of the phase shifter unit. This coupling unit further improves the characteristics of the microstrip to CPW transition unit. The scattering parameters of this unit are plotted in Figure 7. As can be seen the return loss and insertion loss values of -40 dB and -0.1 dB are achieved at the operating frequency of 10.4 GHz, respectively.

#### 5. Phased array antenna employing MEMS phase shifters

The proposed phased array antenna is shown in Figure 8. It is composed of 8 radiating elements arranged linearly. As labeled in Figure 8, the



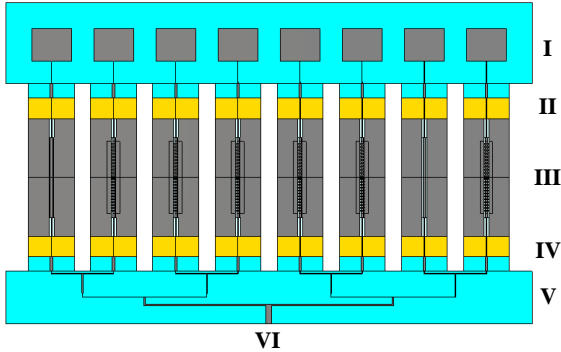
**Figure 7:** S-parameters of the microstrip to CPW conversion unit.

antenna consists of microstrip patch antenna (I), microstrip to CPW and vice versa conversion units (II, IV), MEMS phase shifter (III), power distribution and feed lines (V), and connection to 50  $\Omega$  feed line (VI). Reflection coefficient of the phased array antenna when the main lobe is at 0° is shown in Figure 9. For this case, phase shifter bridges are at the up state with sufficient distance from the CPW line which introduce no effect on the feed line. As can be seen, the return loss of the phased array antenna is -12 dB and the bandwidth is about 100 MHz.

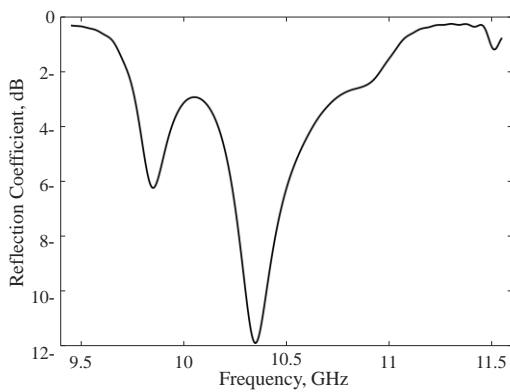
Figure 10 shows the radiating pattern of the antenna operating at 10.4 GHz, while the main lobe is at boresight (0°). The main beam gain is 15 dB, beam width is 10.6°, and side lobe level is -13.1 dB. In order to steer the beam and locate it for instance at 15.7, the required phase shift which is provided by the phase shifters are 0°, 60°, 120°, 180°, 240°, 300°, 0°, and 60°, respectively. The mentioned phase shifts and essentially any

## Phased array antenna using MEMS phase shifter

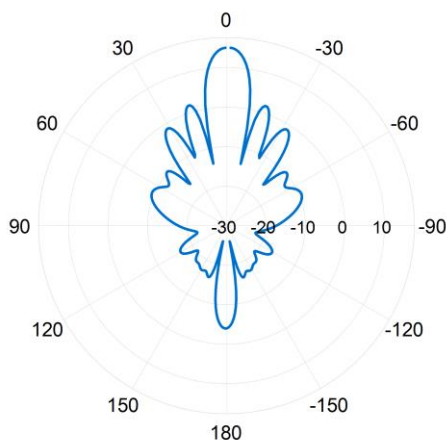
required phase shift which is a multiple of  $15^\circ$  is realized using the corresponding control signal applied to the bridges. For example, in order to achieve  $60^\circ$  phase shift, control signals applied to four bridges are activated such that the total phase shift of bridges would be  $4 \times 15^\circ = 60^\circ$ .



**Figure 8:** Top view of the proposed phased array antenna employing MEMS phase shifters.

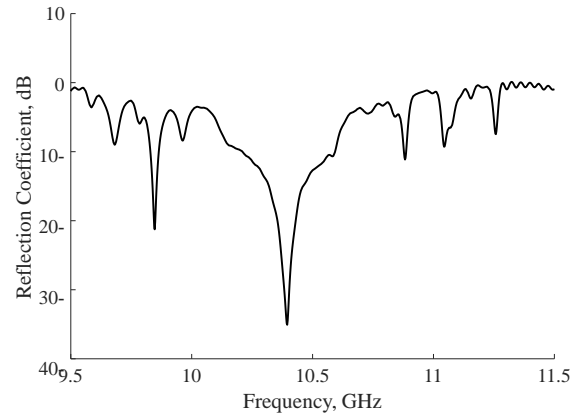


**Figure 9:** Reflection coefficient of the phased array antenna when the main lobe is at  $0^\circ$ .

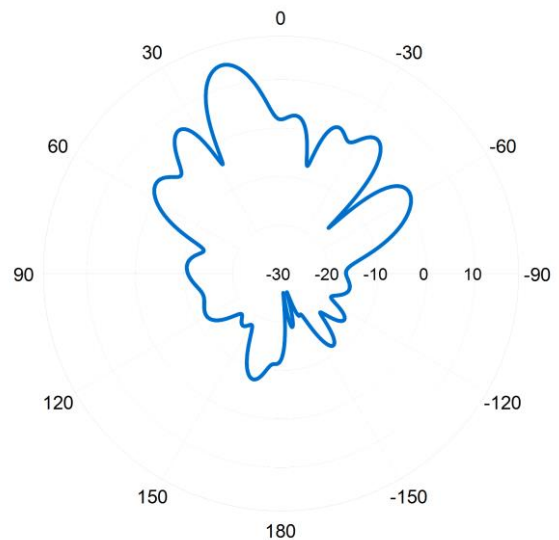


**Figure 10:** Radiating pattern of the antenna operating at 10.4 GHz and the main lobe is at boresight.

Figure 11 shows the reflection coefficient of the phased array antenna while the beam is located at  $15.7^\circ$ . As can be seen the return loss is -35 dB, and the antenna beam width is about 300 MHz. Radiation pattern of the antenna operating at 10.4 GHz and having the beam directed at  $15.7^\circ$  is shown in Figure 12. The main lobe has a gain of 14.6 dB, antenna beam width is  $11.8^\circ$  and side lobe level is -8.4 dB. Figure 13 shows the Cartesian radiation pattern for the two cases where the beam is at  $0^\circ$  and  $15.7^\circ$ .

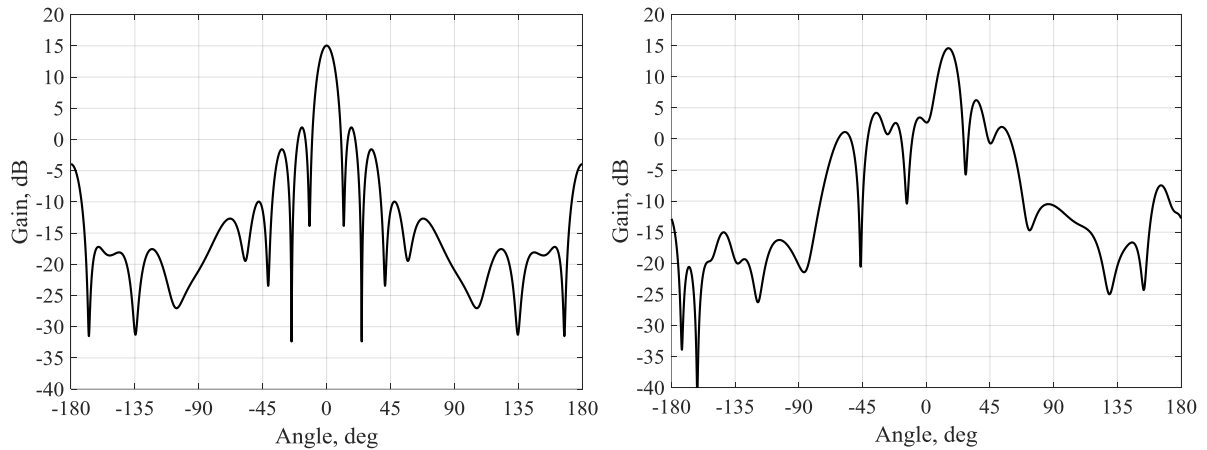


**Figure 11:** Reflection coefficient of the phased array antenna when the main lobe is at  $15.7^\circ$ .



**Figure 12:** Antenna radiation pattern operating at 10.4 GHz and the beam at  $15.7^\circ$ .





**Figure 13:** Cartesian radiation pattern while the beam is at:  $0^\circ$  (left) and  $15.7^\circ$  (right).

## 6. Conclusions

This article proposed the procedure to design a phased array antenna realized by MEMS phase shifters operating by a series of suspended capacitive bridges. The numerical results of the antenna characteristics while the main beam is at different angles are presented. The developed phased array antenna is operating at 10.4 GHz. The designed MEMS phase shifter employs 24 suspended bridges which are controlled separately to provide phase shifts with  $15^\circ$  resolutions. When the control signal is applied to the bridges suspended above CPW transmission lines, the attraction electrostatic force reduces the distance between the two conductive layers of the bridge on top and the bottom electrode. This provides a loading effect on the line which in turn, produces a phase shift for the passing signal. Two low-loss conversion units are employed for the transition between the microstrip and CPW lines. Numerical analysis results for the radiation patterns and scattering parameters for different main beam angles are presented. The proposed design methodology is presented for the X-band, however, the method might be applied to other frequency bands, such as millimeter-wave frequencies for automotive applications. The results indicate the effectiveness of the employment of the proposed MEMS phase shifter in phased array antennas.

## References

- [1] J. Schoebel, T. Buck, M. Reimann, M. Ulm, M. Schneider, A. Jourdain, G. J. Carchon, and H. A. C. Tilmans, "Design considerations and technology assessment of phased-array antenna systems with RF MEMS for automotive radar applications," *IEEE Trans. Microw. Theory Tech.*, vol. 53, no. 6, pp. 1968–1975, Jun. 2005.
- [2] "Basic principles of networking," in *Bosch Automotive Electrics and Automotive Electronics*, Wiesbaden: Springer Fachmedien Wiesbaden, 2014, pp. 70–81.
- [3] V. K. Varadan, K. J. (Kalarickaparambil J. Vinoy, and K. A. Jose, *RF MEMS and their applications*. John Wiley, 2003.
- [4] F. Reggia and E. Spencer, "A New Technique in Ferrite Phase Shifting for Beam Scanning of Microwave Antennas," *Proc. IRE*, vol. 45, no. 11, pp. 1510–1517, 1957.
- [5] J. F. White, "High Power, p-i-n Diode Controlled, Microwave Transmission Phase Shifters," *IEEE Trans. Microw. Theory Tech.*, vol. 13, no. 2, pp. 233–242, Mar. 1965.
- [6] P. Coget, P. Philippe, V. Pauker, P. Dautriche, and P. Jean, "A multioctave active MMIC quadrature phase shifter,"

- in *Digest of Papers., Microwave and Millimeter-Wave Monolithic Circuits Symposium*, 1989, pp. 75–77.
- [7] S. Barker and G. M. Rebeiz, “Distributed MEMS true-time delay phase shifters and wide-band switches,” *IEEE Trans. Microw. Theory Tech.*, vol. 46, no. 11, pp. 1881–1890, 1998.
- [8] C. A. Balanis, *Modern antenna handbook*. Wiley, 2008.
- [9] G. Wang, “RF MEMS Switches with Novel Materials and Micromachining Techniques for SOC/SOP RF Front Ends,” Ph.D. Dissertation, Georgia Institute of Technology, Atlanta, GA, 2006.
- [10] A. K. Sharma, A. K. Gautam, P. Farinelli, A. Dutta, and S. G. Singh, “A Ku band 5 bit MEMS phase shifter for active electronically steerable phased array applications,” *J. Micromechanics Microengineering*, vol. 25, no. 3, p. 035014, Mar. 2015.
- [11] U. Shah, E. Decrossas, C. Jung-Kubiak, T. Reck, G. Chattopadhyay, I. Mehdi, and J. Oberhammer, “Submillimeter-Wave 3.3-bit RF MEMS Phase Shifter Integrated in Micromachined Waveguide,” *IEEE Trans. Terahertz Sci. Technol.*, pp. 1–10, 2016.
- [12] Yulin Huang, Jingfu Bao, Xinyi Li, Yiling Wang, and Yijia Du, “A 4-bit switched-line phase shifter based on MEMS switches,” in *10th IEEE International Conference on Nano/Micro Engineered and Molecular Systems*, 2015, pp. 405–408.
- [13] A. Abdel Aziz, S. Safavi-Naeini, A. S. Abdellatif, and R. R. Mansour, “Low-loss compact MEMS phase shifter for phased array antennas,” *Electron. Lett.*, vol. 51, no. 15, pp. 1142–1144, Jul. 2015.
- [14] O. D. Gurbuz and G. M. Rebeiz, “A 1.6–2.3-GHz RF MEMS Reconfigurable Quadrature Coupler and Its Application to a 360° Reflective-Type Phase Shifter,” *IEEE Trans. Microw. Theory Tech.*, vol. 63, no. 2, pp. 414–421, Feb. 2015.
- [15] C. A. Balanis, *Antenna theory: analysis and design*. Wiley Interscience, 2005.
- [16] C. J. A. Armenta, S. Porter, and A. Marvin, “Reconfigurable phased array antennas with RF-MEMS on a PCB substrate,” in *2012 Loughborough Antennas & Propagation Conference (LAPC)*, 2012, pp. 1–5.
- [17] Y. Liu, “MEMS and BST Technologies for Microwave Applications,” University of California, Santa Barbara, 2002.
- [18] R. N. Simons, *Coplanar Waveguide Circuits, Components, and Systems*. John Wiley & Sons, 2001.